



## APV Gasketed Plate Heat Exchangers

GPHE-MANUAL-EN  
ISSUED: 1000E-GB

READ AND UNDERSTAND THIS MANUAL PRIOR TO  
OPERATING OR SERVICING THIS PRODUCT.





**Always observe the Safety Notes designated by the Warning symbol:  Listed throughout this manual.**

 Leakage from a DuoSafety plate is always the early warning for the user to act. ([See page 12](#))

 APV Paraweld PHE - Care must be exercised in connecting the fluids correctly. ([See page 13](#))

 APV Paraweld PHE is not suitable for hygienic duties. ([See page 13](#))

 Some general safety precautions must be followed in order to avoid personal injury or equipment damage. ([See page 14](#))

 Lifting equipment must be in good condition and should always be used in full compliance with the specifications and limitations given for the equipment. ([See page 17](#))

 Always maintain the minimum angle between the lifting wires in order not to exceed the allowable wire tension. The angle should not exceed 120° at any time. ([See page 17](#))

 Always observe proper procedures for lifting and/or moving equipment and qualified personnel for the lifting and moving. ([See page 17](#))

 Ensure sufficient space around the plate heat exchanger. ([See page 18](#))

 Ozone-producing equipment, salt air and other corrosive atmospheres must be avoided at all times. ([See page 19](#))

 Start-up of the plate heat exchanger. ([See page 20](#))

 Exceeding the design temperatures and pressures can be harmful. ([See page 20](#))

 Sudden changes in the operating pressures and temperatures should be avoided. ([See page 21](#))

 Never open the APV plate heat exchanger until the unit has cooled below 40°C (105°F). ([See page 23](#))

 Never open an APV heat exchanger, which is under pressure from any source. ([See page 23](#))

 Never open an APV plate heat exchanger with piping connected to the follower or connector grids. ([See page 23](#))

 Bolts must not be slackened or tightened indiscriminately. ([See page 23](#))

 For large units, block the follower into position, for example by tying it to the end support, to provide extra safety against accidental rolling of the follower during maintenance. ([See page 23](#))

 Always wear protective gloves when handling plates. ([See page 23](#))

 Cleaning agents must not be aggressive or corrosive to the plates or the gaskets. If in doubt, contact the cleaning agent supplier. ([See page 25](#))

 Do not use chlorine-containing agents such as hydrochloric acid (HCl). ([See page 26](#))

 Excess Nitric acid can seriously damage NBR and other types of rubber gaskets. ([See page 26](#))

 Do not permanently bend or scratch the plates or damage the gaskets during the installation. Some plates must be carefully bent to install them. ([See page 29](#))

 Always tighten to full plate to plate contact, demonstrated by sufficient force and within the dimensions permitted. On the nameplate or the assembly drawing, you will find the minimum and maximum compressed dimension of the plate pack. ([See page 31](#))

 Insufficient clamping force can cause leaking. ([See page 32](#))

 For best rigidity of plate pack, tighten used plates to the same dimension again. ([See page 32](#))

 Never over tighten without written consent from APV as this can damage the flow plates. ([See page 32](#))

## Index

Index .....	2
Index .....	3
1. Main components.....	6
2. Operating Principle .....	9
2.1 Standard design.....	9
2.2 Frame.....	9
2.3 Sanitary plate heat exchangers.....	10
2.3.1 Grids and bosses .....	10
2.3.2 Spray screen.....	11
2.3.3 Divider plates .....	11
2.4 APV DuoSafety – double wall plates.....	12
2.5 APV ParaWeld – welded plate pairs .....	13
2.6 Inline Filters.....	13
3. General safety precautions .....	14
4. Receiving of equipment .....	15
4.1 Receiving check.....	15
4.2 Documents.....	15
4.2.1 Assembly drawing.....	15
4.2.2 General arrangement drawing .....	16
4.2.3 PHE Plate Arrangement drawing .....	16
4.3 Name plate.....	16
5. Handling.....	17
5.1 Lifting .....	17
6. Installation.....	18
6.1 Foundation.....	18
6.2 Space requirements.....	18
6.3 Connections .....	18
7. Storage .....	19
7.1 Short Term Storage (less than 6 months) .....	19
7.2 Long Term Storage (more than 6 months).....	19
8. Start-up and operation .....	20
8.1 Start up .....	20
8.2 Operation .....	20
8.2.1 Corrosion resistance .....	21
8.3 Shutting down .....	21
9. Maintenance .....	23
9.1 Disassembly.....	23
9.2 Cleaning.....	25
9.2.1 Manual Cleaning .....	25
9.2.2 Cleaning-In-Place.....	26
9.3 Regular DuoSafety internal inspection .....	28
9.4 Gasket replacement.....	29

9.5 Re-assembly .....	29
9.6 Maintenance of in-line filter .....	33
10. Spare Parts – Identification and Ordering .....	34
10.1 Identification of spare parts .....	34
11. Troubleshooting .....	35

**Note:** Illustrations of ParaFlow heat exchangers and equipment presented in this manual serve as example illustrations only in support of the instructions. Your actual equipment may look different.

**Important!**

In addition to this instruction manual, the following key documents are included with your APV ParaFlow plate heat exchanger. In case of conflict between this instruction manual and the order and product documents, the order and product specific documents take precedence.

- APV PHE Plate Arrangement Drawing
- APV Assembly Drawing which may be integrated with the plate arrangement drawing
- Other Order-specific documentation
- Supplementary Instruction manuals dealing with specific topics

Further details can be found in Section 4: "Receiving equipment".

**How to contact APV:**

Your nearest APV office is listed on our website [www.apv.com](http://www.apv.com). Please also go to [apv.com](http://apv.com) to find information regarding our Service and Spare Parts offerings.

**Dear Customer.**

**Thank you for choosing APV equipment!**

The purpose of this manual is to provide you with important information on operating your APV Plate Heat Exchanger.

This manual covers the APV ParaFlow gasketed plate heat exchangers. Separate publications describe other APV equipment.

**Read this manual carefully before unpacking the equipment.**

## 1. Main components

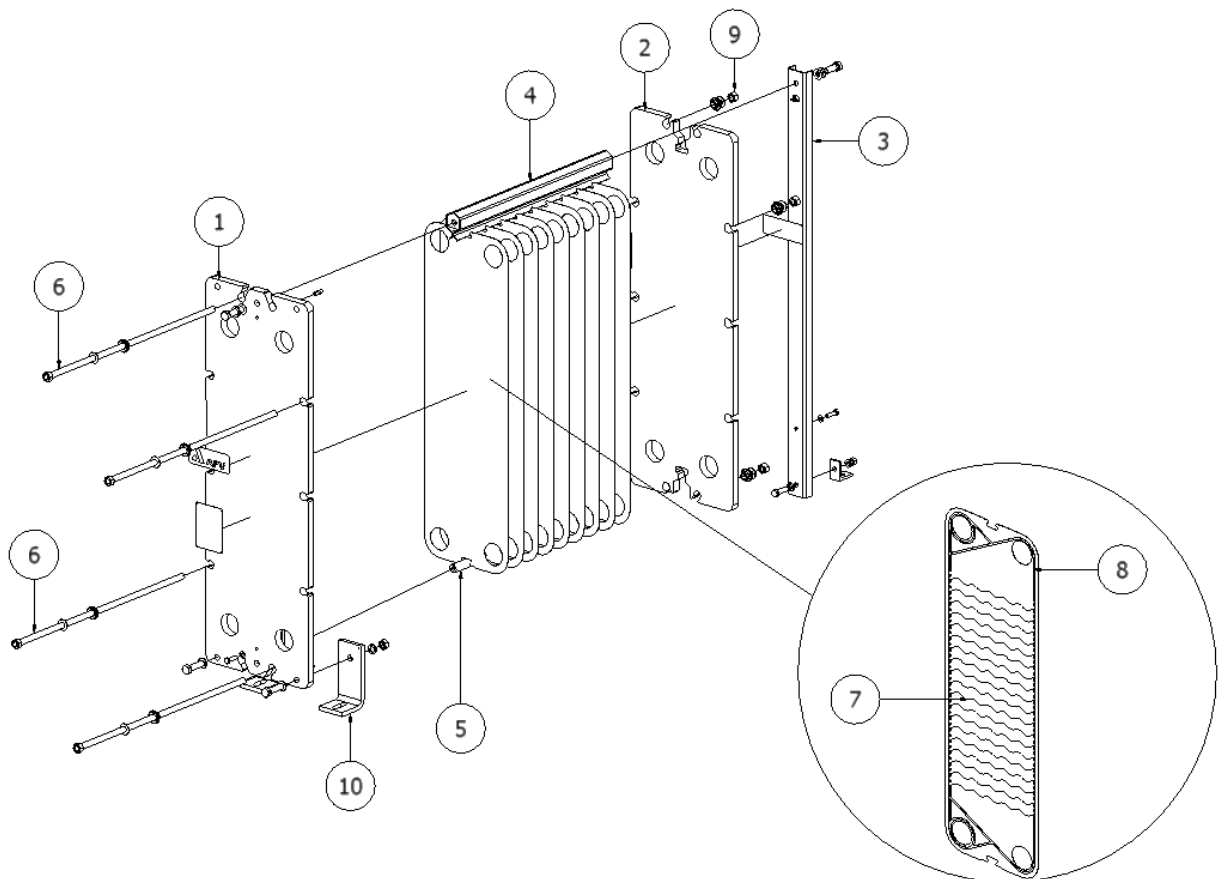

A typical small APV ParaFlow PHE

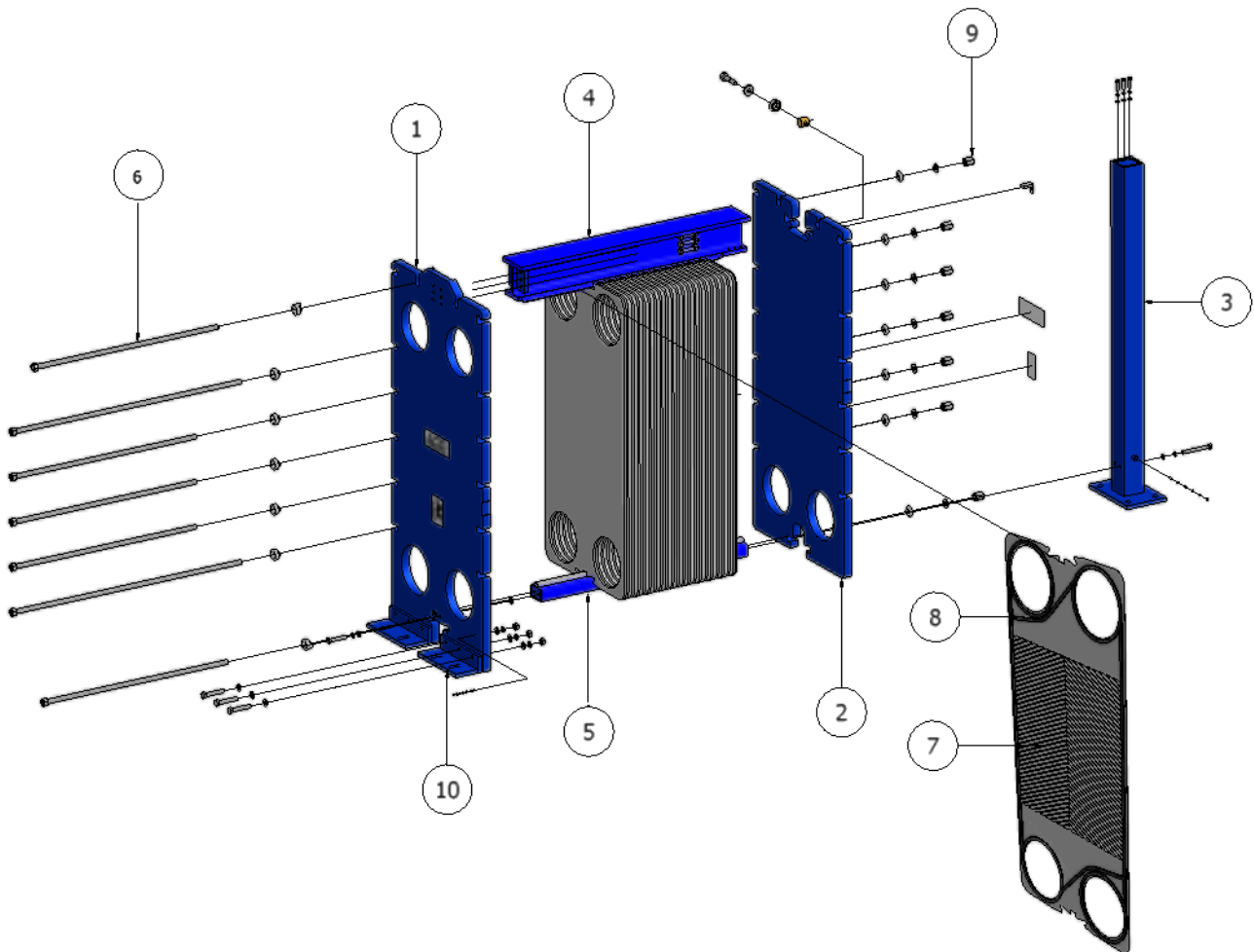

A typical large APV ParaFlow PHE

**Figure 1: Main components of APV gasketed plate heat exchanger, industrial design**

1. **Head** for connections and clamping the plate pack
2. **Follower** for clamping the plate pack and any additional connections
3. **End support** for supporting the top and bottom bars
4. **Top bar** for carrying and guiding the follower and plate pack
5. **Bottom bar** for guiding the follower and plate pack
6. **Tie bars** for clamping the plate pack between head and follower
7. **Flow plate**
8. **Flow gasket**
9. **Nut** for tie bar
10. **Footplate** for securing the plate heat exchanger to the base.

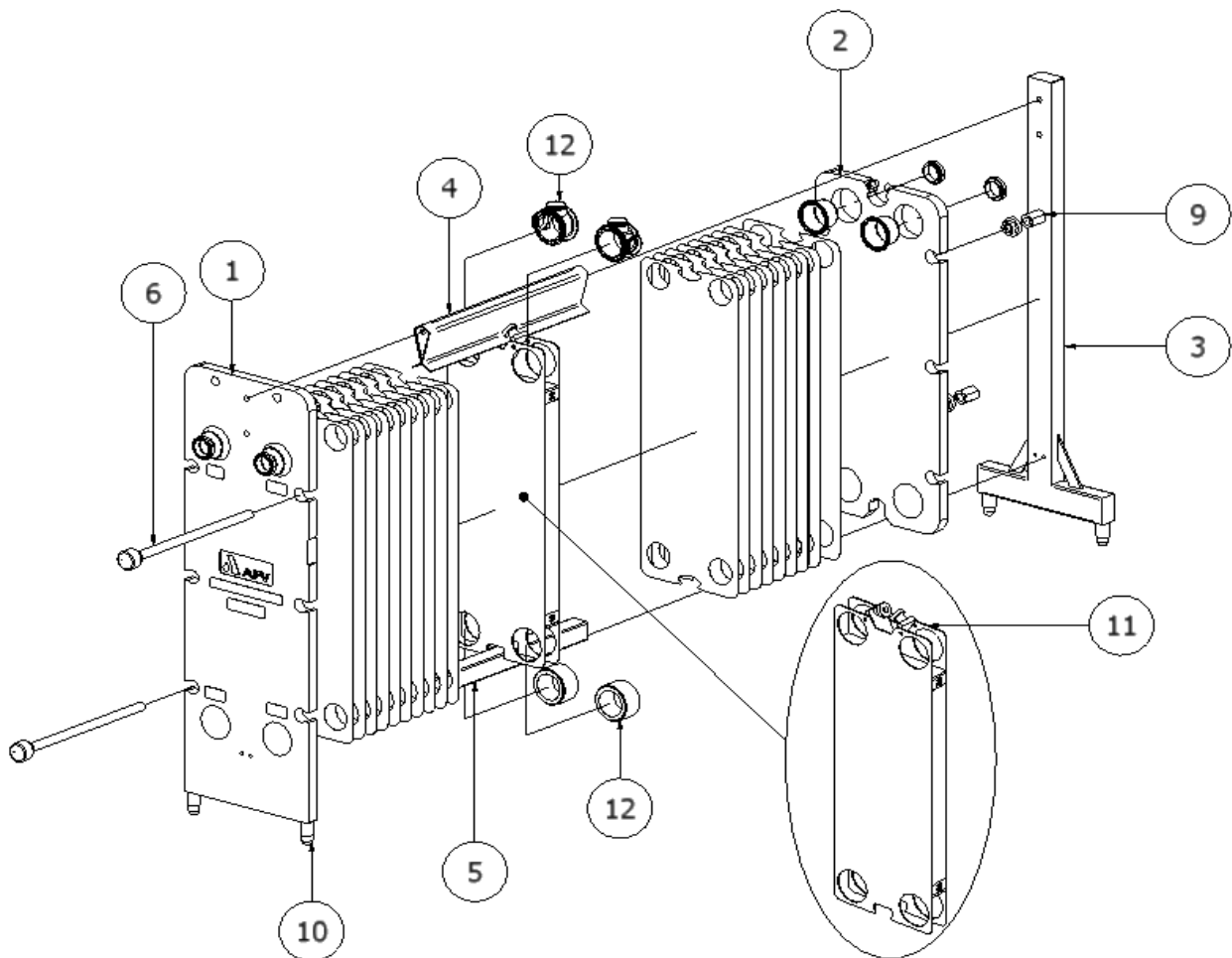

**Figure 2: Main components of typical APV sanitary / hygienic plate heat exchanger.**

1. **Head** for connections and clamping the plate pack
2. **Follower** for clamping the plate pack
3. **End support** for supporting the top and bottom bars
4. **Top bar** for carrying and guiding the follower and plate pack
5. **Bottom bar** for guiding the follower and plate pack
6. **Tie bars** for clamping the plate pack between head and follower
7. Flow plate (Figure 1)
8. Flow gasket (Figure 1)
9. **Nut** for tie bar
10. **Adjustable** or fixed legs
11. **Connector grid** for additional fluid connector bosses
12. **Connector bosses**



## 2. Operating Principle

### 2.1 Standard design

The plate heat exchanger consists of a number of thin corrugated metal plates.

The plate corrugations form flow channels for the heat exchanging fluids and provide strength to the compressed plate pack.

The plates contain ports for fluid inlets, outlets and interconnect passages as required.

Gaskets are attached to the plates, forming a seal between the heat exchanging fluids and the surroundings.

In the example shown here, the cold fluid (blue) enters at the bottom and the hot fluid (red) at the top.

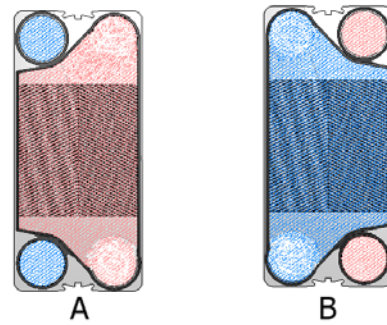
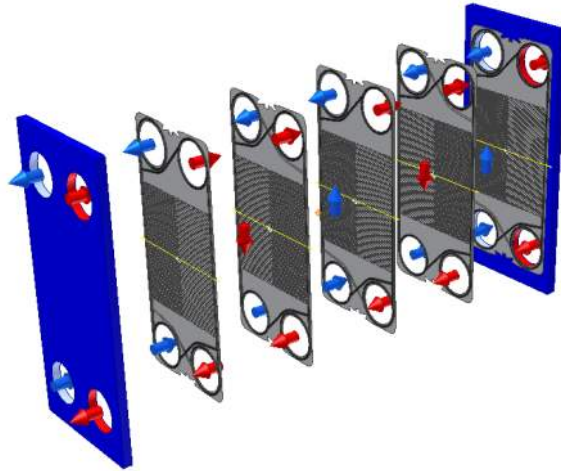

### 2.2 Frame

The plates are clamped together to a predetermined dimension by the tie bars between two thick metal slabs: a stationary slab (head) and a moveable slab (follower). Connections for the fluid inlets and outlets can be made on either slab. The plates are hung on the top bar and guided by the bottom bar. An end column supports the top and bottom bar ends.

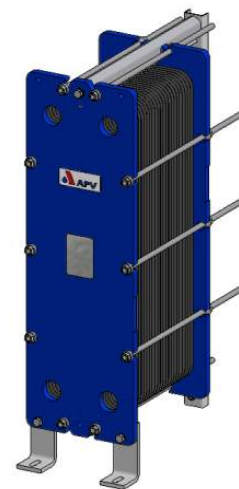

## 2.3 Sanitary plate heat exchangers

Frames used for sanitary or hygienic duties are fabricated in solid stainless steel or carbon steel with stainless steel covering. Standard connections are usually sanitary tube fittings. Industrial fittings may be supplied when required.

Plates may be either parallel flow or diagonal flow.

**i** Note: The type of plate, whether parallel or diagonal, affects the position of the fluid inlet and outlet connections, left/right.

Parallel plates have both flow inlet and outlet ports on the same side, e.g. left side for the hot medium and right side for the cold medium.

For diagonal plates, however, if the fluid enters the channel in the left corner, then it leaves the channel in the right corner

Parallel plates require only one type of plate, while diagonal plates require two different plates to form a flow channel.

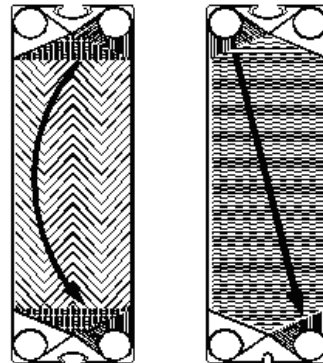

### 2.3.1 Grids and bosses

The intermediate grid divides the plate heat exchanger into separate sections that may operate independently. The connector grids are equipped with removable connector bosses made from stainless steel.

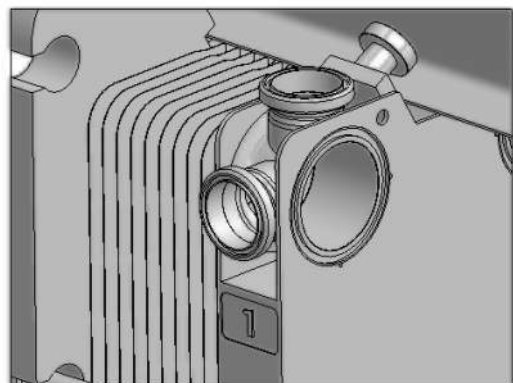

The connector bosses can also form the connections between sections of the plate heat exchanger and provide external connections to and from these sections.

### 2.3.2 Spray screen

A spray screen can be mounted on the plate pack for protection. The spray screen is made from folded stainless steel and it is hung on the top bar or tie bars of the plate heat exchanger for easy installation and removal.

**i** Note: Use of a spray screen is recommended whenever corrosive liquids or high temperatures present a safety hazard to personnel.

A spray screen may be supplied for new or existing plate heat exchangers.



### 2.3.3 Divider plates

A divider plate is typically a solid steel plate between 6 and 10 mm thick. The divider plate has the same outer shape as the flow plates.

Divider plates are used to divide a heat exchanger into two separate operating sections. Divider plates have no external connections but do allow flow from one section to the next through their ports.

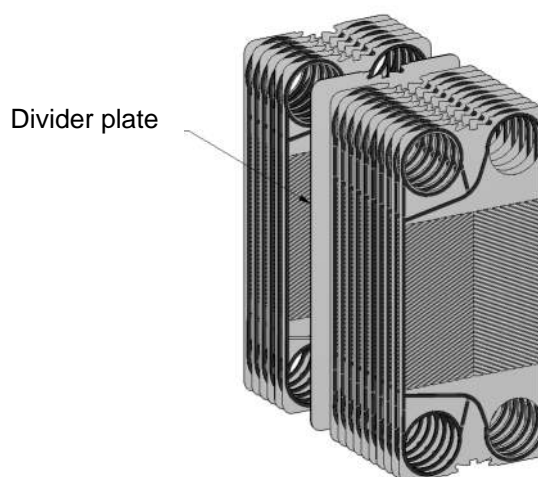

## 2.4 APV DuoSafety – double wall plates

The APV DuoSafety heat exchanger plate is a double wall plate manufactured from two loose plates pressed together to form a DuoSafety plate. Each APV DuoSafety plate pair is equipped with a non-glue gasket, which seals and holds the plates together. The two plates can be made of the same or different materials.

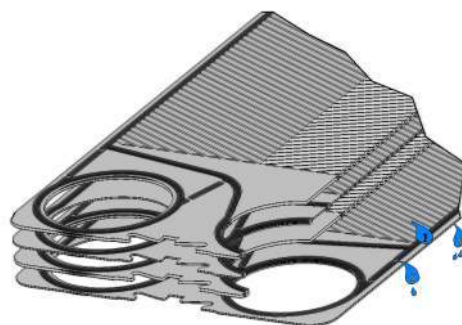

The space between the two plates of the APV DuoSafety plate pair serves as a safety zone in case of through-plate leaks. Should a leak occur in this safety zone (i.e. because of corrosion, wear or age of seals), this space provides an extra security against mixing of the two liquids. The liquid will be discharged from the space between the two walls into the atmosphere and avoid cross-contamination.

When leakage from a plate heat exchanger containing DuoSafety plates is observed, immediate action must be taken to detect and replace the defective items before corrosion or wear can proceed through both plate walls and pose a risk of contamination. If a DuoSafety heat exchanger is fitted with a spray screen, it may be necessary to regularly remove the screen to observe that the plate pack edges have no tell-tale sign of leakage. A visual check should be made at least every 3 months.

**⚠** Leakage from a DuoSafety plate is always the early warning for the user to act.

**ⓘ** Note!: DuoSafety plates often use special gaskets which can be confused with gaskets meant for single plates which look similar. Please confirm with APV that you have the correct gaskets



## 2.5 APV ParaWeld – welded plate pairs

APV ParaWeld plate pair is a right- and left-hand plate laser welded together to form a pair. This welded plate pair system is particularly suitable for use with refrigerants such as ammonia and Freon or with other aggressive liquids that could otherwise attack the gaskets in a conventional heat exchanger plate.

When the welded pairs are installed in a frame, each pair is sealed by elastomeric seals.

**ⓘ Note:** An APV ParaWeld plate pair cannot be separated for inspection and cleaning. It is, therefore, important to prevent fouling and clogging of the welded passage. If fouling in the welded passage cannot be prevented, then cleaning must be done by circulating a cleaning solution. It is recommended that you contact a supplier of cleaning agents for advice.

**⚠** The two sides of APV Paraweld PHE may have different pressure and fluid compatibility and therefore care must be exercised in connecting the fluids correctly.

**⚠** APV Paraweld PHE is not suitable for hygienic duties where organic fouling is expected, for example, dairy products.

## 2.6 Inline Filters

For industrial applications involving fibres or particles which might foul the heat exchanger plates or block the heat exchanger passages, an APV in-line filter is recommended.

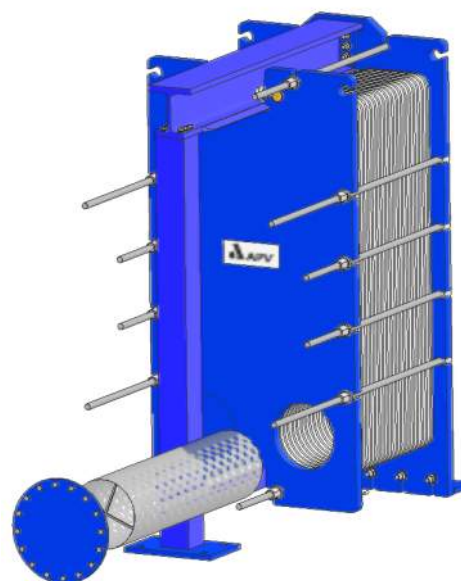
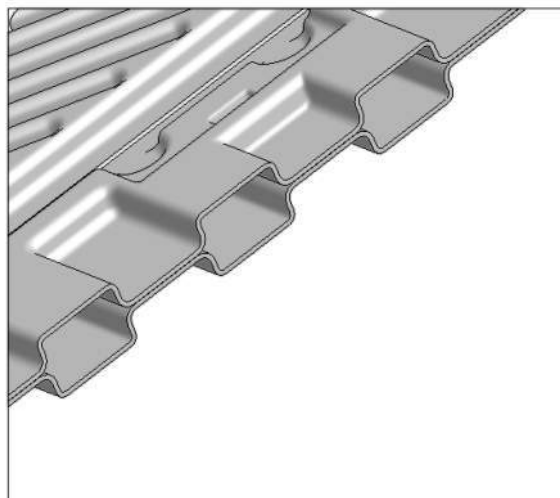

The APV in-line filter is inserted in the fluid inlet port of the heat exchanger through an opening in the follower and closed with a full-faced gasket blind cover.

The in-line filter mesh size is 2.5 mm (0.1 inch).

Where an in-line filter is purchased for an existing APV PHE, please check whether the follower is prepared for the installation of an in-line filter. A replacement follower or machining may become necessary.

### 3. General safety precautions

Always observe the **Safety Notes designated by the Warning symbol: ** Listed throughout this manual.

APV Plate Heat Exchangers are designed and manufactured with due consideration and care for generally accepted safety standards. As with any mechanical device, the proper and safe performance of the equipment depends on safe handling, operation, and maintenance.

**** The following general safety precautions must be followed in order to avoid personal injury or equipment damage:

1. Always observe any applicable local and national safety codes.
2. Always use appropriate protective gear, such as safety gloves and safety shoes when touching and handling the equipment.
3. Follow proper lifting procedures while handling the equipment.
4. Never expose the equipment to heat, aggressive chemicals or mechanical impact that can damage the equipment.
5. Only qualified persons should handle and operate the equipment.



## 4. Receiving of equipment

### 4.1 Receiving check

APV Plate Heat Exchangers may be shipped fully assembled and skid mounted. The PHE is normally mounted on pallets and wrapped in protective plastic. Other wrappings could be in open box or seaworthy packaging.

Prior to unpacking, check the packing for any defects and the equipment for possible damage that might have occurred during transportation. Any damage as a result of shipping must be reported immediately.

Check the equipment according to the documentation provided with the shipment. Any deviations must be reported immediately.



### 4.2 Documents

The following documents are included with the equipment: including the following drawings that can be separate or integrated into one (customer drawing):

- Assembly drawing or General arrangement drawing
- PHE Plate Arrangement drawing including part list
- Other order or product specific documents

#### 4.2.1 Assembly drawing

This drawing provides information concerning overall dimensions, bolt-down positions and a connection diagram showing where external piping will be connected.

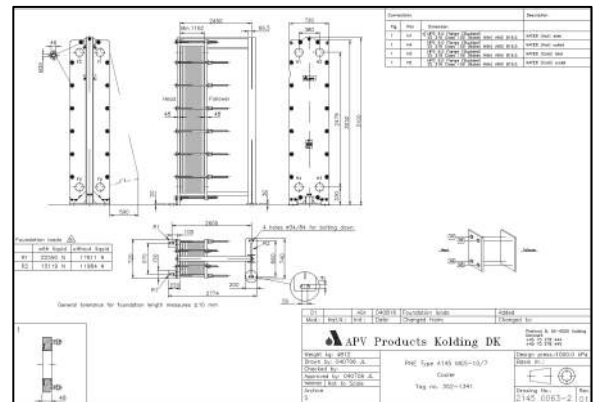

#### 4.2.2 General arrangement drawing

This general arrangement drawing provides the same detailed information, as the assembly drawing plus other customer specified details.

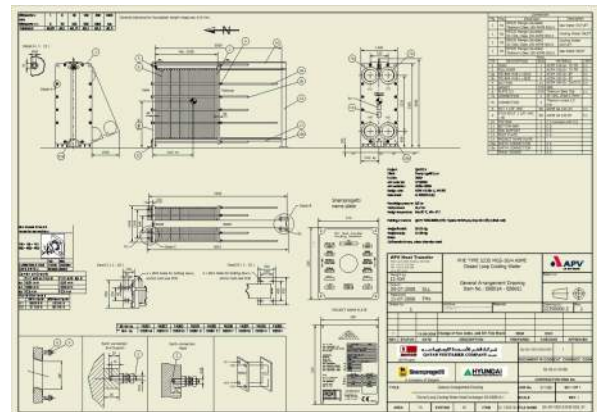

#### 4.2.3 PHE Plate Arrangement drawing

The plate heat exchanger is designed to perform a duty (or duties) by arranging the number and type of plates required in a specific sequence. This arrangement is represented schematically by the plate diagram shown on the arrangement drawing. The drawing summarizes the plates and gaskets in the plate heat exchanger design. The summary includes plate types, angles, thickness and material, along with gasket type, material and attachment method (glued or clip in) and part no. The assembly drawing summarizes compressed plate pack dimension, total weight and hold-up volume.

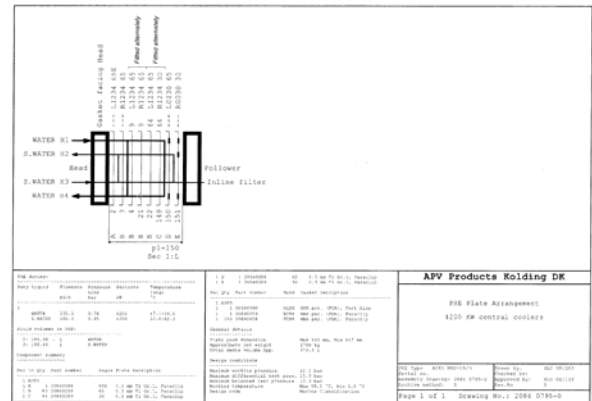

#### 4.3 Name plate

Identification of the equipment is printed on the nameplate (mounted on the head or follower). When contacting APV for service or spare parts, always refer to the serial number on the nameplate.

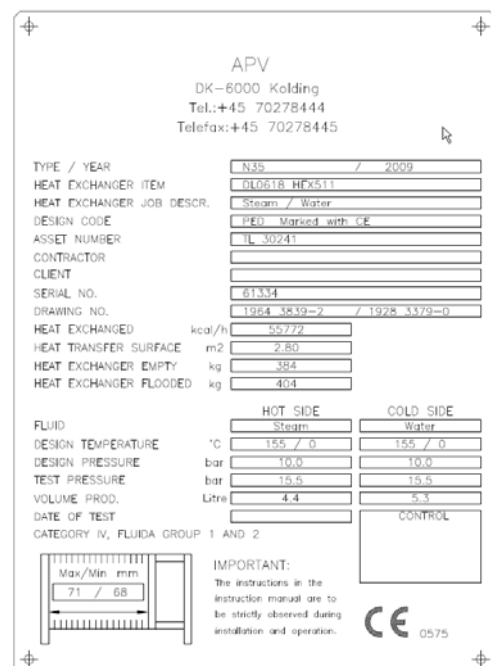



## 5. Handling

### 5.1 Lifting

If the plate heat exchanger is packed and transported lying flat on the head, great care must be taken during raising it, to avoid sliding and impact of bending forces to the equipment base or feet.

APV Plate Heat Exchangers are provided with lifting lugs or holes for safe lifting and transportation of the unpacked equipment.

When lifting an assembled heat exchanger frame, ensure that the lifting point is above the centre of gravity of the equipment.

**⚠** The lifting equipment must be in good condition and should always be used in full compliance with the specifications and limitations given for the equipment.

**⚠** Always maintain the minimum angle between the lifting wires in order not to exceed the allowable wire tension. The angle should not exceed  $120^\circ$  at any time

If the ceiling height does not allow for safe lifting angle, dollies or creepers can be used for moving the equipment.

**⚠** Always observe proper procedures for lifting and/or moving equipment and qualified personnel for the lifting and moving. Personnel must follow safe rigging practices.

Indiscriminate use of fork lift trucks may damage the PHE in critical areas.

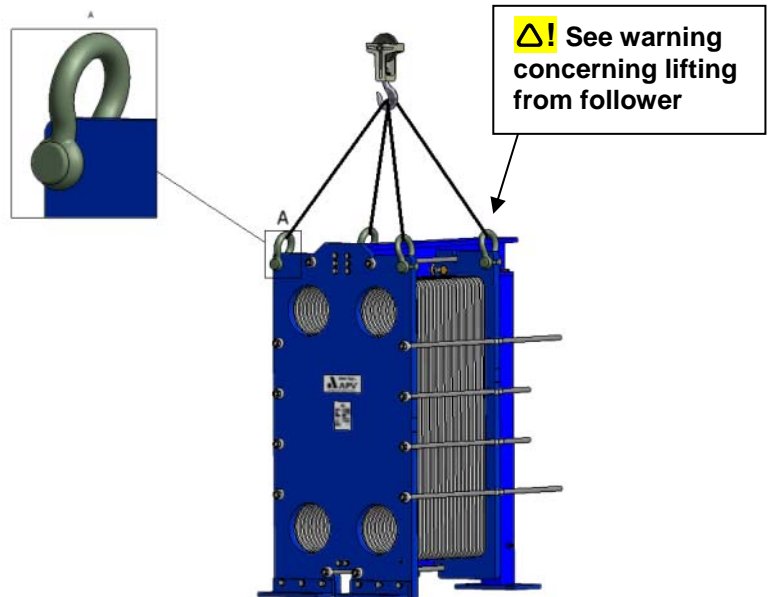

**⚠** Warning: Lifting from the follower shown above is not acceptable for some models and plate damage may result. Check for warning signs on the follower supplied. Use alternative lifting eyes for example as shown below in those cases

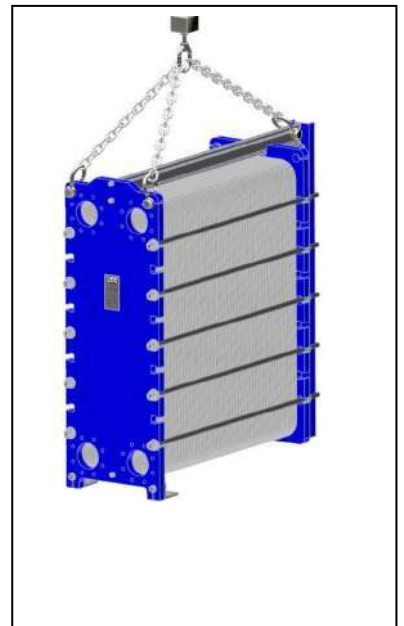
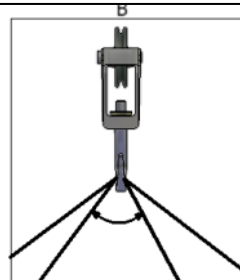

## 6. Installation

### 6.1 Foundation

The APV Plate Heat Exchanger should be placed on a solid foundation floor. If the unit is provided with feet, the dimensions and placement of these are stated on the assembly drawing.

### 6.2 Space requirements

Ensure that there is sufficient space around the plate heat exchanger to separate the plate pack and to remove or insert plates. The amount of free space required is stated on the assembly drawing.

**⚠** Ensure sufficient space around the plate heat exchanger.

### 6.3 Connections

If the plate heat exchanger has liquid connections on the follower, it is important that the compressed dimension is checked against the drawing before the pipes are connected. For easy disassembly and reassembly of the plate heat exchanger, a pipe elbow should be used at all follower connections.

The plate heat exchanger connections on the follower and connector grids have little strength against pipe work or nozzle loads. Such loads can arise for example from thermal expansion. Proper care must be taken to avoid transfer of such pipe forces and moments to the PHE.

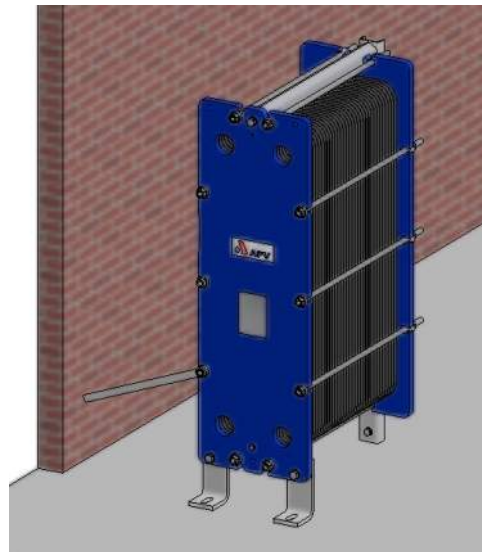

## 7. Storage

### 7.1 Short Term Storage (less than 6 months)

The plate heat exchanger must be stored in a cool and dry environment away from sunlight. It must be protected from water and debris with a waterproof cover, while also allowing for air circulation.

### 7.2 Long Term Storage (more than 6 months)

The heat exchanger must be stored in a cool and dry environment away from sunlight. It must be protected by a waterproof cover against water and debris, however still allowing for air circulation.

**⚠** Ozone-producing equipment, salt air and other corrosive atmospheres must be avoided at all times.

All connections must be closed to prevent water or debris to enter the heat exchanger. Factory installed plugs or covers may be used.

To extend gasket service lifetime, it is recommended to relax the gaskets by loosening the tie bars by approximately 10% of the compressed plate pack dimensions.

## 8. Start-up and operation

### 8.1 Start up

**⚠** Start-up of the plate heat exchanger must be undertaken slowly and smoothly to avoid any pressure shocks/water hammering which might damage the equipment or cause leakage.



Do not allow pressure changes of more than 10 bar (150 psi) per minute. Temperature changes may be harder to control but ideally should be limited to less than 10 deg C (20 deg F) per minute. Cyclic hydraulic or thermal conditions can cause serious damage to the PHE.

If the plate heat exchanger is provided with shut-off valves at the inlets, these should be closed prior to start-up and then opened slowly after pump start-up  
For sanitary heat exchangers with multiple sections, also read section 9.4 titled Reassembly before proceeding.

### 8.2 Operation

The APV plate heat exchangers are designed according to predefined temperatures, allowable pressure drops, design pressures and fluid compositions.

**⚠** Exceeding the design temperatures and pressures can be harmful to the equipment and personnel, and must be avoided.



Deviations from the designated fluid composition may cause corrosion of the plates and damage on the gaskets, even if the deviations occur over relatively short time periods.

### **8.2.1 Corrosion resistance**

Before entering into operation you should assure that the media do not exceed the corrosion resistance level of the materials chosen for your Plate Heat Exchanger. Even unprocessed water may contain such high level of corrosive content (e.g. chloride content) that it may attack the plate surface. A high temperature may accelerate the corrosion process. Visit [www.apv.com](http://www.apv.com) for more info.

For DuoSafety PHE's, regular external leakage inspection must be made of the plate pack edges, to look for leaks as they will start quite small and can quickly evaporate. Where CIP-cleaning is carried out at regular intervals, check approximately 30 minutes after starting the circulation of hot CIP liquid, thoroughly inspecting the floor below the plate pack for any drops. Leakage is more easily detected if the area under the plate pack is dry before the inspection procedure starts. If the floor is not dry, an indicator liquid must be sprayed on the floor and on the plate pack to detect product or CIP drops from the heat exchanger.

### **8.3 Shutting down**

The heat exchanger must be shut down slowly and allowed to cool naturally to ambient temperature. Inlet valves, if used, should be closed before closing the outlet valves.

If steam is used as a heating medium, it must be shut off first. In chilling duties, the cooling

liquid must be shut down first to avoid freezing of the product.

**⚠** Sudden changes in the operating pressures and temperatures should be avoided. Shock cooling of the heat exchanger may cause leakages, due to sudden contraction of the sealing gaskets.



All liquids should be drained from the heat exchanger after shut down to prevent precipitation of products or scale build-up. In the case of corrosive media, it may also be necessary to flush with clean, non-corrosive water.

## 9. Maintenance

**⚠** Never open the APV plate heat exchanger until the unit has cooled below 40°C (105°F).



**⚠** Never open an APV heat exchanger, which is under pressure from any source.

**⚠** Never open an APV plate heat exchanger with piping connected to the follower or connector grids.

### 9.1 Disassembly

Close the shut-off valves and drain the heat exchanger as much as possible.

Disconnect any pipes connected to the follower.

Loosening and tightening of tie bars in the APV Medium and Small range plate heat exchangers can normally be accomplished with ratchet wrenches/ spanners. Larger units require hydraulic equipment or pneumatic/ electric torque converters.

Measure and record the compressed dimension of the plate pack before loosening the tie bars.

**⚠** As for any bolted vessel, bolts must not be slackened or tightened indiscriminately, but approaching a cylinder head sequence, balancing the opening on the right and left throughout the process.



In the process below, dimension X is the initial compressed dimension of the plate pack.

Loosen all tie bars in 3 mm increments to “X + 5%”, and then remove only the 2 top and the 2 bottom tie bars in the positions shown in the picture.

Loosen rest off the tie bars in increments of up to 6 mm to “X + 10%”.

For large or tall units ( where the distance between tie bars labelled 1 and 3, exceeds 1200 mm, 4 ft), remove all tie bars except 1 to 6. Loosen tie bars 1 to 6, moving in that order, in increments of max. 25mm until all tie bars become loose.

For smaller units, (distance between bars 1 and 3 is less than 1200 mm, 4 ft) remove all tie bars except 1 to 4. Loosen tie bars 1 to 4, moving in that order, in increments of max. 25mm until all tie bars become loose.

When using hydraulic tightening units, ensure that each tie bar is loosened equally during opening.

When the plate pack is fully released and the tie bars removed, the heat exchanger can be opened by pushing the follower back against the end support.

**⚠** For large units, block the follower into position, for example by tying it to the end support, to provide extra safety against accidental rolling of the follower during maintenance.

Separate the plate pack carefully to avoid damaging the gaskets or the plates.

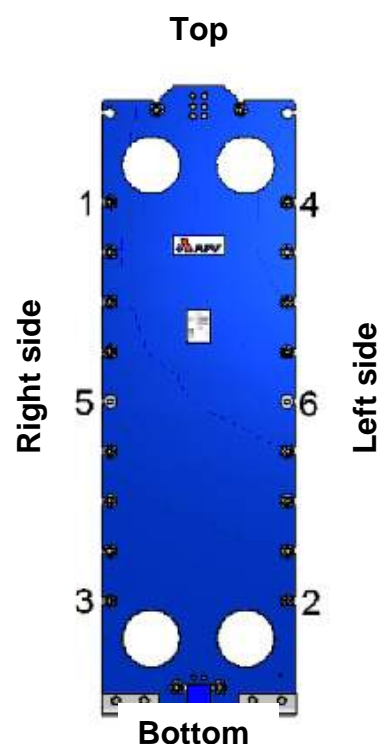
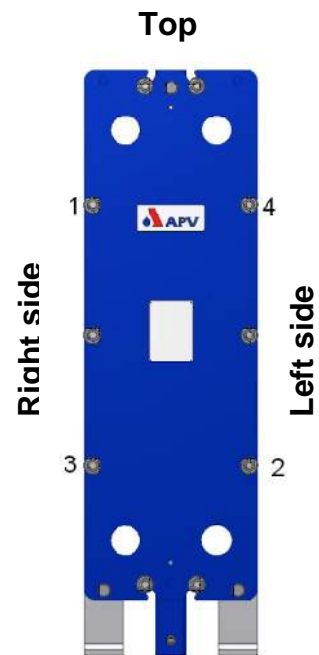





**⚠** Always wear protective gloves when handling plates.

Remove the plates by lifting them backwards and then sideways off the top bar and then sliding out of the frame.

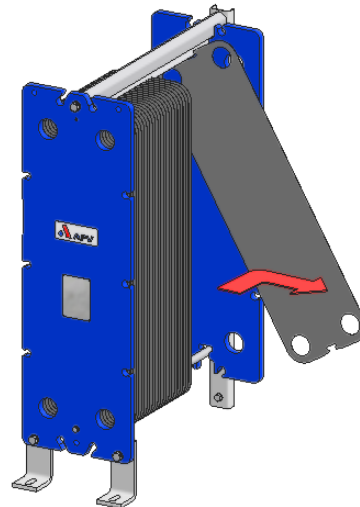

## 9.2 Cleaning

The plate heat exchanger can be cleaned without opening (i.e. cleaning-in-place) and manual cleaning.

### 9.2.1 Manual Cleaning

Manual cleaning is normally accomplished by washing down the plates with a soft non metal brush, water and a cleaning agent.

**⚠** Cleaning agents must not be aggressive or corrosive to the plates or the gaskets. If in doubt, contact the cleaning agent supplier.

Cleaning agents should always be used according to safety regulations and as specified by the supplier.

It is recommended to lay the plate on a flat surface during brush cleaning to avoid the risk of bending the plate.

If the heat exchanger is heavily fouled, care must be taken to remove all debris from the gasket sealing surfaces when the heat exchanger is reassembled. Any debris will most likely lead to sealing failures. Do not

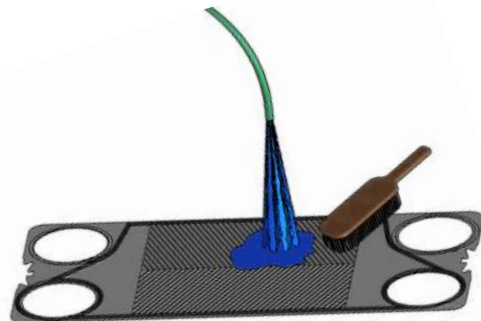

forget that for glue free gaskets, gasket sealing surfaces to be checked are at the top as well as bottom surface of the gasket.

In many cases, fouling may be far too tenacious. APV service centres around the world may be approached for thorough cleaning and inspection of the plate pack and regasketing.

### **9.2.2 Cleaning-In-Place**

Cleaning in place (CIP) is accomplished by circulating a suitable cleaning solution through the plate heat exchanger instead of opening it.

CIP works best in the reverse direction of normal flow. Good results are also possible with same direction flow and at higher velocities than the product flow velocity.

The cleaning solution must be circulated at sufficient velocity to flush out the product. Higher viscosity products generally require higher velocity flushing to properly clean.

The cleaning solution must be able to dissolve the fouling on the plates and great care must be taken to select a proper cleaning solution that does not damage plates or gaskets.



#### **Example of CIP-cleaning:**

- 1 Drain product residues, cooling and heating media.
- 2 Rinse with cold or lukewarm water.
- 3 Circulate warm cleaning fluid solution.
- 4 Rinse with warm water or warm water with softener added.
- 5 Rinse with cold or lukewarm water.

In simple cases cleaning can also be effected without circulation but by pouring a cleaning fluid solution into the system.

After some time of standing, flush the solution with clean water.

If the heat exchanger is to be out of service for a long time, it is advisable to empty it, separate the plates, and clean the unit. After cleaning, lightly re-clamp the plate pack and cover it to protect from dirt and UV light. Please refer to section 7.0 on Storage.

### **Determination of correct CIP system**

The heat exchanger must be opened for inspection at regular intervals. This is necessary especially during the initial start up period, until experience has been gained on the effectiveness of the cleaning regime. With these inspections, it will gradually be possible to determine circulation times, temperatures, and chemical concentrations with great certainty.

Insufficient cleaning is most often due to:

- Insufficient circulation rate.
- Insufficient cleaning time or temperature.
- Insufficient Concentration of the cleaning agent.
- Excessive periods of operation.

**⚠!** Do not use chlorine-containing agents such as hydrochloric acid (HCl).



Example of an acceptable solution for dairy

applications and AISI 316 plates and NBR

gaskets:

- Oils and fats are removed with a water-emulsifying oil solvent, e.g. BP-System Cleaner.
- Organics and greasy coatings are removed with Sodium hydroxide (NaOH) -max. concentration 2.0% - max. temperature 85°C (185°F). 2.0% concentration corresponds to 5.0 litre 30% NaOH per 100 litre water.
- Mineral scale deposits are removed with Nitric acid (HNO<sub>3</sub>)-max. concentration 0.5% - max. temperature 65°C (150°F). 0.5 % concentration corresponds to 0.58 litre 62% HNO<sub>3</sub> per 100 litres water.
- **⚠** Excess Nitric acid can seriously damage NBR and other types of rubber gaskets.
- Non-organic deposits can be removed by special APV Clean.
- Several alternatives to Nitric acid can be used, e.g.: Phosphoric acid up to 5% and 85°C.

### 9.3 Regular DuoSafety internal inspection

Regular **internal** DuoSafety plate pair inspections must be made. APV recommends at least an annual inspection for AISI316 heat exchangers. The plate heat exchanger must be opened and the DuoSafety plate pair separated. Carefully check the inside surfaces for traces of the product/ liquid processed in the heat exchanger. If visual inspection of the surface is difficult (e.g. because the product is transparent) then it is recommended that indicator dye is sprayed onto the inside surface of the plate pairs.

Fouling between the DuoSafety plate pair indicates that at least one of the DuoSafety plates has a defect. In this case, both plates in the DuoSafety plate pair must be removed from the plate heat exchanger.

#### 9.4 Gasket replacement

For ordering of spare parts and for re-gasketing, refer to section 10: "Spare Parts". In a small number of cases, gaskets may be attached with glue. For the correct and important processes for removing the glued gasket correctly and fitting of new gaskets correctly, consult APV service.

#### 9.5 Re-assembly

Wipe the top bar clean with a soft cloth. Apply suitable grease on the hanging surface where plates will slide.

When replacing old plates, ensure that the new plates are reinstalled in the correct sequence and orientation as stated on the PHE Plate arrangement drawing.

**⚠** Do not permanently bend or scratch the plates or damage the gaskets during the installation. Some plates must be carefully bent to install them.

Push the plates towards the head checking carefully that they are correctly mounted.



When the plate pack has been correctly assembled, in most models, plate edges will create a honeycomb. So, check the edge of the plate pack for unusual patterns before tightening the PHE.

Check the tie bars. Brush clean and grease over the working lengths.

Once the plate pack has been carefully pushed towards the fixed head and then the follower is pushed against the plate pack, then tie bar have to be placed in their positions

In the process below, dimension X is the final intended compressed dimension of the plate pack.

For small to mid sized units  
(Distance between bars 1 and 3 < 1200 mm)

Compress plate pack in small increments, moving diagonally from one tie bar to the next. Reach final dimension X + 10% by tightening bars 1 to 4 in the order given, in increments of 25 mm or less. Then add all left side and right side bars and tighten all bars to dimension X+5% in increment of 6 mm or less. Then add the 2 top and 2 bottom bars and compress in 3 mm increments to X.

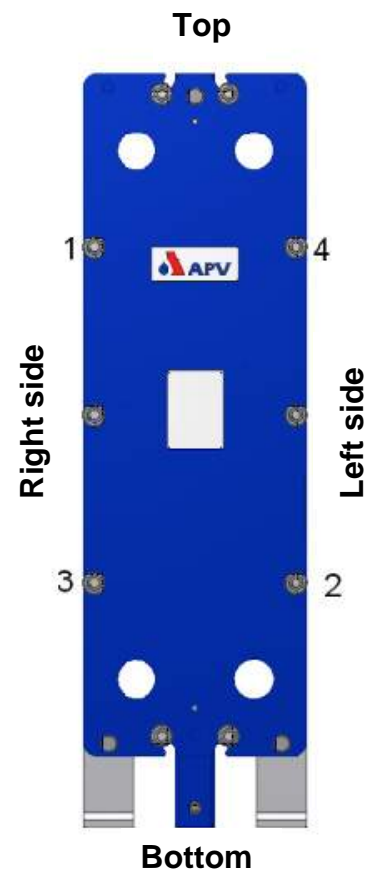
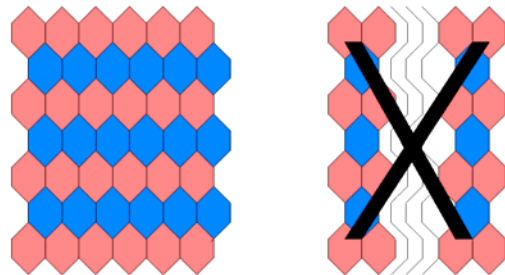

### For large units

(Distance between bars 1 and 3 >1200 mm)

Compress plate pack in small increments, always moving diagonally from one tie bar to the next. Reach final dimension  $X + 10\%$  by tightening bars 1 to 6 in the order given, in increments of 25 mm or less. Then add all left side and right side bars. Tighten all bars to dimension  $X+5\%$  in increment of 6 mm or less. Then add the 2 top and 2 bottom bars and compress in 3 mm increments to  $X$ .

By using hydraulic compression tools 2, 4 or 6 bolts can be compressed at the same time. The order of bolts and increments must be the same as above.

It's important that head and follower are kept parallel during the compression work. In this regard, compression must be measured at the top, middle, and bottom sides. Measurements are to be taken close to the tie bars.

**⚠** Always tighten to full plate to plate contact, demonstrated by sufficient force and within the dimensions permitted. On the nameplate or the assembly drawing, you will find the minimum and maximum compressed dimension of the plate pack.

In multi section machines, differences in pressures through the sections can set up a concertina effect where higher pressure sections open up by a few hundredths of millimetres per plate and lower pressure sections close down. Opening up of higher pressure sections can cause leakage of that section. The robustness of the PHE is also

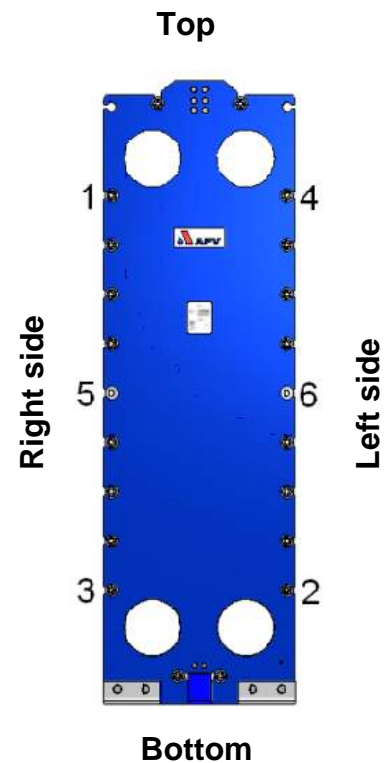

linked with the percentage division of plate counts in various sections.

! To ensure leak free operation in such applications, it is even more important that the plates contact well with each other. Well contacting plates are far more resistant to the concertina effect. Always tighten to full plate contact.

The concertina effect at minimum compressed dimension is always very small and therefore the plate pack is more rigid and robust against leakage.

Irrespective of new or old plates or a mix of new and old plates, the plates must always be compressed to full contact. Due to tolerances the full plate contact is attained between maximum and minimum compressed pitch. Full plate contact is indicated by rapidly raising compression force. See illustration as an example.

**⚠** Insufficient clamping force can cause leaking.

**⚠** For best rigidity of plate pack, tighten used plates to the same dimension again.

**⚠** Never over tighten without written consent from APV as this can damage the flow plates.

Check the heat exchanger sealing before pipes on the follower are connected.

After any changes, a hydraulic pressure test should be made prior to operation of the unit. We recommend a leak test at 1.1 x operating pressure.

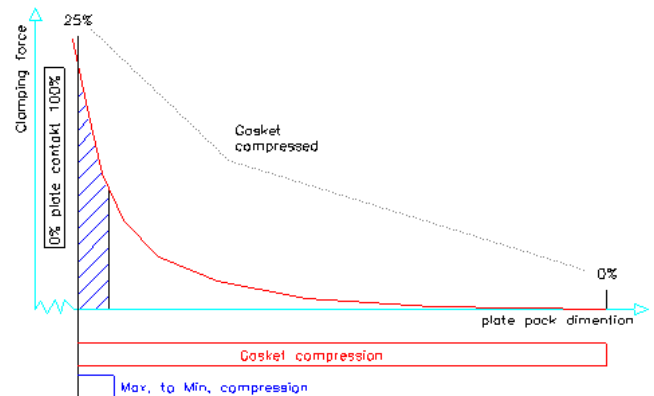
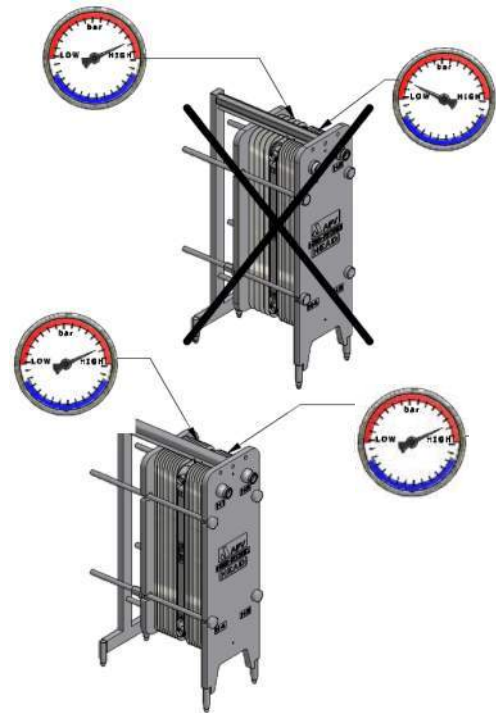



## 9.6 Maintenance of in-line filter

The in-line filter where supplied needs to be cleaned at regular intervals. The frequency depends on the content and size of debris in the fluid being filtered. An increase in the pressure drop over the heat exchanger indicates the need for cleaning.

### Clean the in-line filter in this sequence:

1. Stop fluid circulation pump.
2. Close valve on the filter side.
3. Drain the filter side.
4. Remove the full-faced gasketed blind flange on the follower.
5. Carefully pull out the in-line filter through the follower.
6. Clean the filter with water and brush. Soap which is not damaging the filter material (AISI 316) may be used.
7. Before reinserting the in-line filter it is recommended that you flush any loose debris from the port where the filter is installed.
8. Carefully re-insert the filter in the fluid inlet port through the follower.
9. Check that the full-faced gasket is in place on the blind flange.
10. Place the blind flange on the follower.
11. Open the valve on the filter side and release air.
12. You may now start your circulation pump.

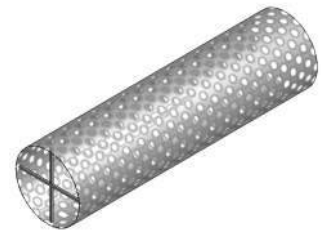

## 10. Spare Parts – Identification and Ordering

### 10.1 Identification of spare parts

Each spare part of the APV heat exchanger is allocated a unique Item Number.

For gaskets and heat exchanger plates see Item Numbers on PHE Plate arrangement drawing.

On some heat exchanger plates, the last four digits of the item number are also stamped near one end of the plate. On some gaskets, the part number may be moulded on the gasket. Plate punch code and plate inversion – left and right are shown in the picture here.

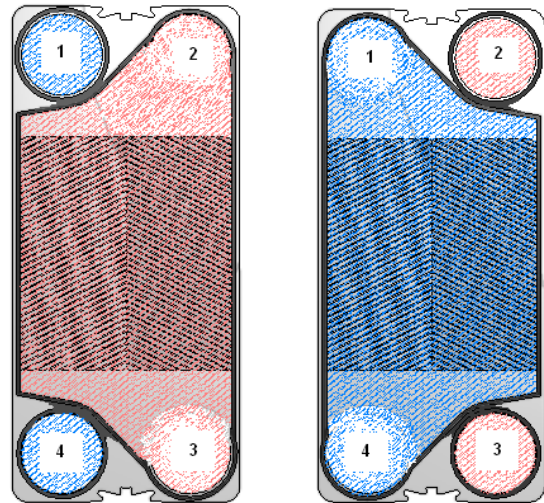

Right hand plate

Left hand plate

Plate handing is checked by which lower port will allow flow into the channel. For the right hand plate, the right hand lower port allows flow to enter or leave the channel. Etc.

## 11. Troubleshooting

1 Troubleshooting plate heat exchangers		
Problem	Possible Causes	Suggested Solutions
1. <b>Reduced heat transfer</b>	<ul style="list-style-type: none"> <li>a. The inlet temperatures or flow rates do not correspond to the original design.</li> <li>b. Plate surfaces have become fouled on either the product or service side.</li> <li>c. Freeze-up.</li> </ul>	<p>Correct temperatures or flow rates to design conditions.</p> <p>Open the heat exchanger and clean the plates or clean the plates (without opening) by circulating a suitable cleaning agent or reverse flush to dislodge debris.</p> <p>Correct temperatures or flow rates to design conditions.</p>
2. <b>Increased pressure drop or reduced flow rate</b>	<ul style="list-style-type: none"> <li>a. Plate surfaces have become fouled on either the product or service side.</li> <li>b. Debris is blocking the flow channels.</li> </ul>	<p>See paragraph 1(b) above.</p> <p>Open the heat exchanger and clean the plates (see Section 6.0). Screens or filters must be installed to prevent debris from entering the unit. Reverse flush to dislodge debris.</p>
3. <b>Visible leakage</b>	<ul style="list-style-type: none"> <li>a. Operating pressure exceeds the rating of the heat exchanger.</li> <li>b. The heat exchanger is not tightened adequately for the operating conditions.</li> <li>c. Sealing surfaces of plates or gaskets maybe damaged or dirty.</li> <li>d. Chemical attack on the gaskets.</li> </ul>	<p>Reduce the operating pressure to the rating of the heat exchanger. If the unit continues to leak after the pressure is reduced, the plates or gaskets might be damaged or gaskets aged and may require replacement.</p> <p>Tighten the heat exchanger further in increments of .001 inch (0.025 mm) per plate, checking for leakage each time. Do not tighten below the minimum dimensions given in the general arrangement drawing. If leaks continue, see paragraph below.</p> <p>Open the heat exchanger and inspect the plates and gaskets. There must not be any cuts, cracks, debris or flat spots on the gaskets. Glue free gaskets must not have any debris under the gasket. The plates must be clean and free of heavy scratches or dents on both sides. Replace any defective parts.</p> <p>Identify the source of chemical attack and correct either by eliminating the corrosive agent or changing the material of the gaskets.</p>
4. <b>Cross-contamination</b>	<ul style="list-style-type: none"> <li>a. Cracks in one or more plates. These may be caused by fatigue resulting from pressure fluctuations during operation.</li> <li>b. Holes in the plates caused by corrosion.</li> </ul>	<p>Open the heat exchanger and inspect the plates. Replace the defective parts. Identify the source of pressure fluctuations and correct.</p> <p>Dye-penetrant or alternative in situ testing may be required to identify cracks in the plates. If this is the case, refer to Factory Service.</p> <p>Identify the source of corrosion and correct by either eliminating the corrosive agent or changing the material of the plates.</p>

APV Gasketed

Plate Heat Exchangers



**SPX Flow Technology**

Platinvej 8  
6000 Kolding  
Denmark

T: +45 70 278 444  
F: +45 70 278 445  
E: apv.emea.heat@spx.com

**SPX Flow Technology**

1200 West Ash Street  
P.O. Box 1718 Goldsboro  
North Carolina 27533-1718  
USA

T: +1 (919) 735-4570  
F: +1 (919) 731-5498  
E: answers.us@spx.com

For more information about our worldwide locations, approvals, certifications, and local representatives, please visit [www.spx.com](http://www.spx.com).

The information contained in this document, including any specifications and other product details, are subject to change without notice. While we have taken care to ensure the information is accurate at the time of going to press, we assume no responsibility for errors or omissions nor for any damages resulting from the use of the information contained herein.

GPHE-MANUAL-EN

ISSUED: 1000E-GB

COPYRIGHT ©2012 SPX Corporation